

ASD Elegance SG - Structural Glass Balustrade



Tal Y Fan, Wales - Residential Property



Napoleons Casino, Sheffield



Gylly Beach Cafe, Falmouth



Newcastle University

Free standing dry-glazed Balustrade system

- Secure & Tested (3 kN/m loading to BS 6180)
- Ready-to-install kit
- Cost effective system (reduced labour costs on site)
- Modern frameless design

Scope of applications:

- Commercial, residential and public buildings
- Indoor and outdoor applications
- Suitable for 15, 17.5, 19, 21.5, 25 & 25.5mm glass

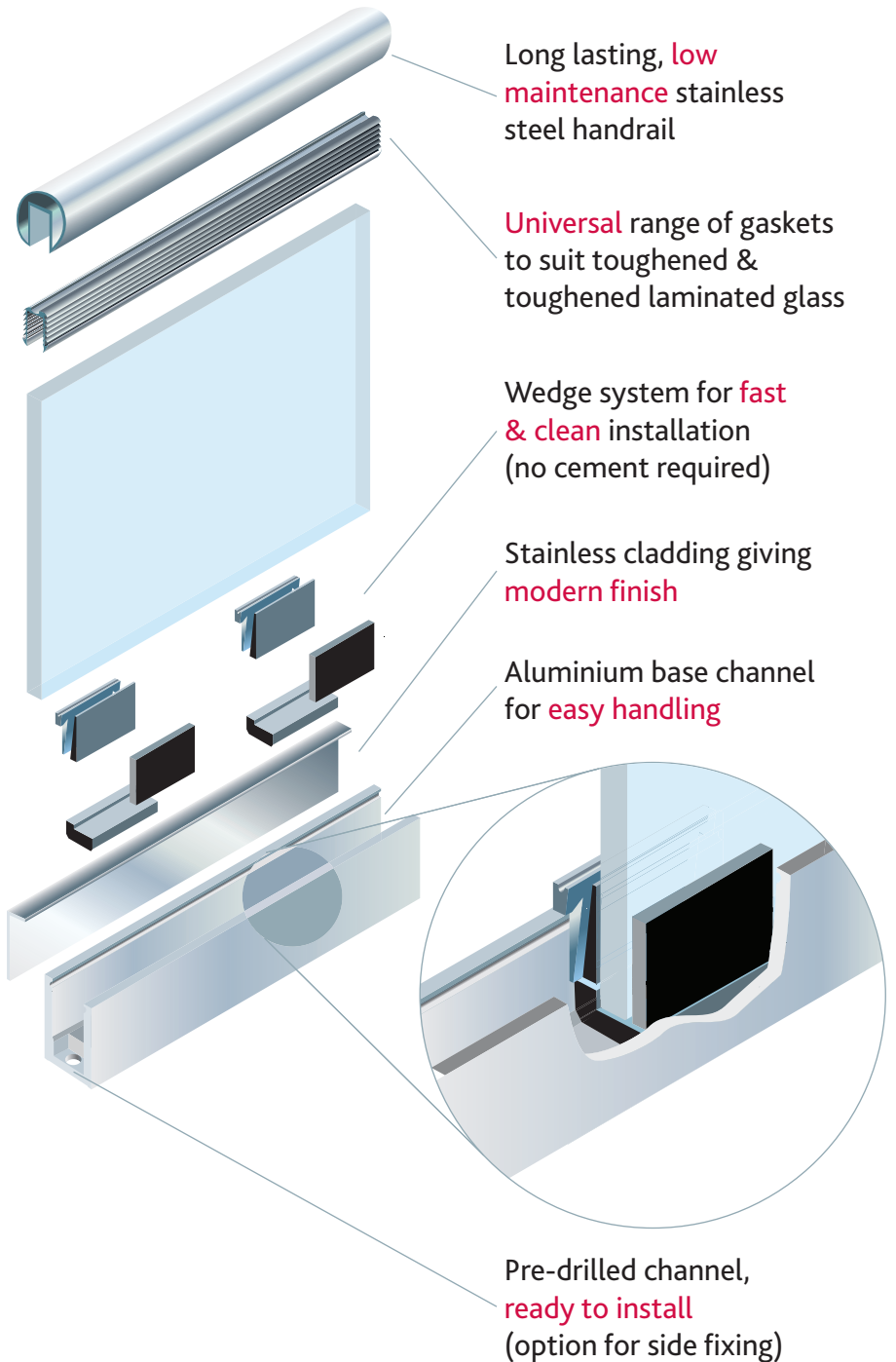



BSI Barrier Load Test Summary

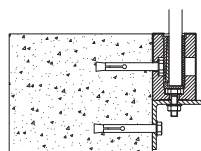
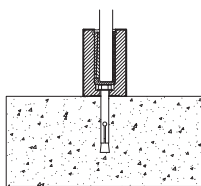
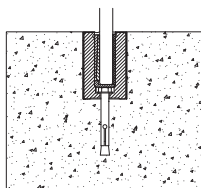
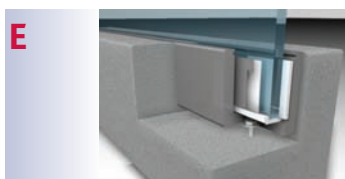
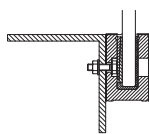
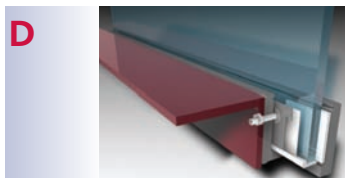
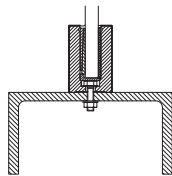
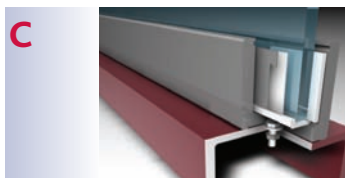
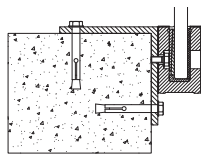
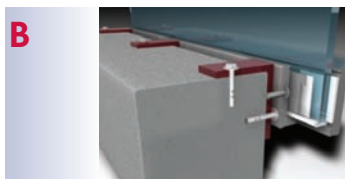
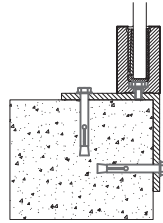
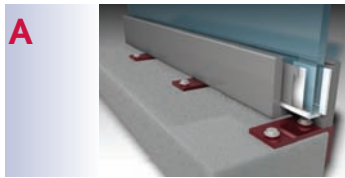

Glass	0.74kN/m	0.8kN/m	1.5kN/m	3kN/m
-------	----------	---------	---------	-------

A (Fischer FII 12/10S fixings through 150x150x10 support angles & M12 (10.9) for channel to straps)

15mm	●	●		
17.5mm EVA	●	●		
19mm			●	
21.5mm EVA	●	●		
25mm				●
25.5mm EVA			●	

B (Fischer FII 12/10S + M12 (10.9) for support angles)

15mm	●			
19mm		●		
25mm			●	

C (with M12 10.9 Hex head bolt)

15mm	●	●		
17.5mm EVA	●			
19mm			●	
21.5mm EVA	●	●		
25mm			●	●
25.5mm EVA			●	

D (with M12 10.9 Hex head bolt)

15mm	●	●		
19mm	●	●		
21.5mm EVA	●	●		
25mm		●	●	
25.5mm EVA	●	●		

E (Fischer FII 12/10S Fixings)

15mm	●	●		
19mm			●	
21.5mm EVA	●	●		
25mm				●

F (Fischer FII 12/10S Fixings)

15mm	●	●		
17.5mm EVA	●			
19mm			●	
21.5mm EVA	●	●		
25.5mm EVA		●	●	

G (Fischer FHB II AL M12x120/10S fixings into concrete & 75x75x6 steel straps & M12 (10.9))

15mm	●			
19mm		●		

NB. For 3KN loading 5 wedges per metre are required.



Simple and fast installation



Newcastle University

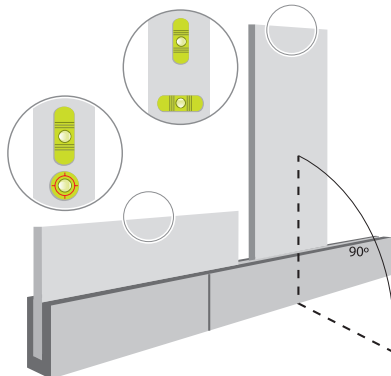

Step 1...

Ensure the base channel is plumb and true and that other base channels are aligned.

Use laser or spirit level, shim if required.

Step 2...

Secure the glass by tapping the aluminium wedges into place, using nylon hammer and suitable chisel. Make sure aluminium wedges are fitted against channel wall (4 wedges required per linear metre except for 3KN loading) NB. When fitting the aluminium wedge it is essential after pressing it in firmly by hand that it protrudes by approx. 15-20mm above the top of the alloy shoe channel.

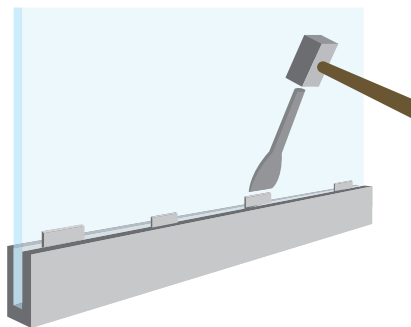

Step 3...

Fit handrail to the top of the glass with appropriate gasket and bond stainless steel cladding to the base channel. (All joints to be silicon sealed)

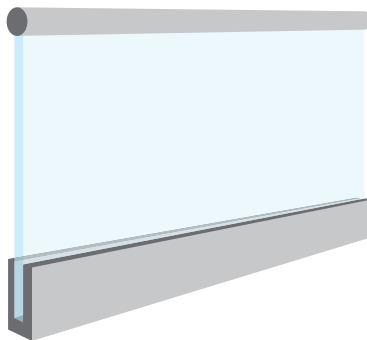

Swindon Academy



SAS Building, Newcastle

Simple and fast deglazing

The removal tool allows the wedges to be removed with ease.

The tool effortlessly removes the aluminium wedges from the shoe allowing quick & easy replacement of damaged or incorrect panes of glass.

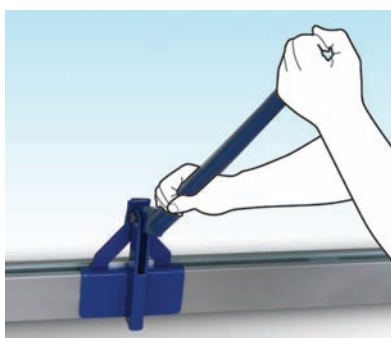

Apartment, Cornwall





Glazing Specification

Glazing table for ASD Elegance SG (All items stocked in the UK)

Please find below component list for each glass thickness.

Options for Base Channel

Product	Glass Thickness					
	15mm	17.5mm	19mm	21.5mm	25mm	25.5mm
Aluminium Shoe						
0100.BF - Pre Drilled - Base	*	*	*	*	*	*
0101.SF - Pre Drilled - Side	*	*	*	*	*	*
* Specify one of the two options						
Wedge pack (4 per pack) 1 pack/lin.m	SGBE-0200.15	SGBE-0202.17.5	SGBE-0201.19	SGBE-0205.21.5	SGBE-0203.25	SGBE-0204.25.5
Satin s/s cladding (3m length) for base channel) (also available in MP)	1 x SGBE-0300.15 1 x SGBE-0301.19	2 x SGBE-0301.19	2 x SGBE-0301.19	2 x SGBE-0301.19	1 x SGBE-0302.25 1 x SGBE-0301.19	1 x SGBE-0302.25 1 x SGBE-0301.19
Satin s/s end cap (also available in MP)	SGBE-0304.END	SGBE-0304.END	SGBE-0304.END	SGBE-0304.END	SGBE-0304.END	SGBE-0304.END



Stainless Steel Tubes and Bars



Glazing Gaskets



Slotted Tube Fittings

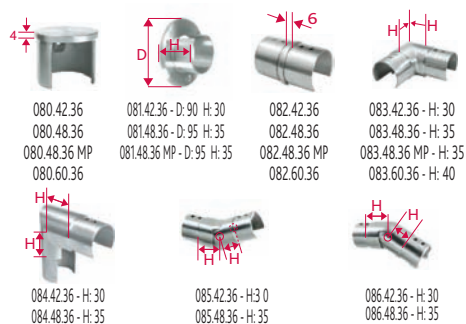

Offset Glass Fittings

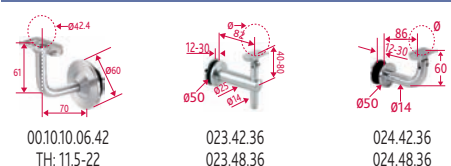

Options for Handrail (satin finish)

Product	Glass Thickness					
	15mm	17.5mm	19mm	21.5mm	25mm	25.5mm
Handrail 42.4 20x20mm **	for use with gasket 090.42.12	silicon glazed	na	na	na	na
Handrail 42.4 24x24mm **	for use with gasket 091.42.15	for use with gasket 091.42.17	for use with gasket 091.42.19	for use with gasket 091.42.21	na	na
Handrail 48.3 27x30mm ** (also available in MP)	for use with gasket 092.48.15	for use with gasket 092.48.15	for use with gasket 092.48.21	for use with gasket 092.48.21	silicone glazed	silicon glazed
Handrail 60.3 35x34mm **	for use with gasket 093.60.15	for use with gasket 093.60.15	for use with gasket 093.60.19	for use with gasket 093.60.19	for use with gasket 093.60.25	for use with gasket 093.60.25

** Specify grade 304 or 316

(MP) also available in mirror polished

Please consult our technical department for 12mm glass

Compatible fittings for slotted handrail (end cap, connectors, wall fixing)

To contact us or for more information please see below
Tel: 0114 234 5288 Fax: 0114 234 1643

ASD Architectural, 901 Herries Road, Hillsborough, Sheffield S6 1QH
elegance@asdmetservices.co.uk www.asdelegance.com

